

# DIY Billboard Lights.com



Installation Guide

## Tools You'll Need

- Level
- Tape measure
- Battery Operated Drill
- Philips Bit / Drill bits
- Screwdrivers
- Wire strippers

### **Additional Items Needed:**

- Deep Cycle Marine Battery
- Extra wire\*
- Screws
- Seal tight connectors, wire nuts
- Wood

*\*Purchase extra wire if solar panel is installed at a high altitude.*

# Installation

## Planning

1. Find the center point of your sign. Draw a line to represent where the mounting brackets will be installed. See *Fig 1*.
2. Mark where the mounting bracket will be attached to the top of the sign. Pre-drill the hole, to make it easier to mount. Use the appropriate drill bit you will be using for mounting. See *Fig 2*.
3. Drill the holes on the light mounting plate to match up with the holes with the light that you have. Secure the light to the mounting plate with your choice of screws. See *Fig 3*.
4. Use 2 butt connectors to splice the wire so that it can be run through the tubing of the mounting bracket. Take a piece of electrical tape with some pull on it to seal it the wire, so when it is pulled through the tubing, the butt connectors don't come apart. See *Fig 4*.



**Fig 1.**



**Fig 2.**



**Fig 3.**

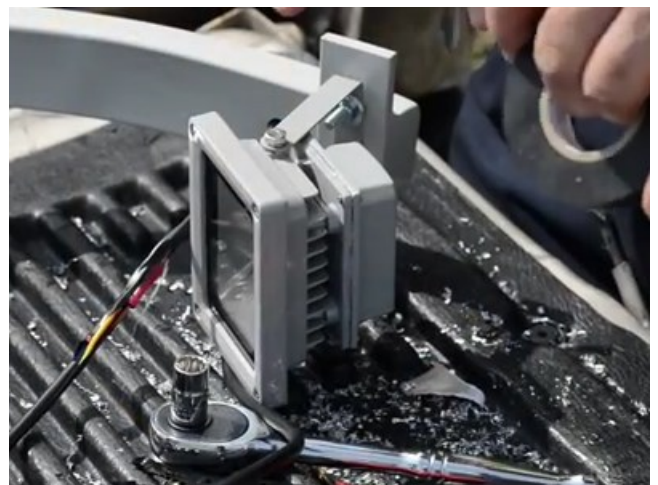

**Fig 4.**

# Installation

## Solar Panel Mounting (applicable to all solar panel sizes)

1. Lay the solar panel bracket across the back of the solar panel near the pre-drilled holes. Mark the holes on the frame of the solar panel on the post.
2. Drill the marked holes on the bracket, making sure they line up with the holes on the frame of the solar panel.
3. Secure the bracket and solar panel using your choice of nuts and bolts.
4. Affix the solar panel bracket to the post.

**Note:** Respect polarity when attaching the wire to the solar panel. Crimp the wires then secure them into the terminals. See Fig 1.



*Attach bracket to back of solar panel.*



*Drill holes for attaching bracket to post.*

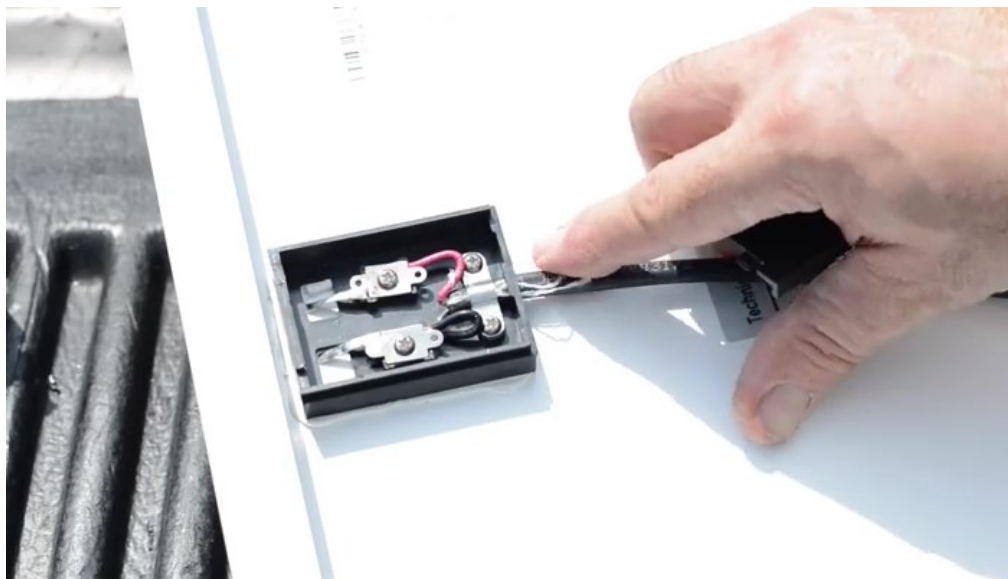

**Fig 1.**



# Installation

## Control Box Installation

1. Mount the din rail inside the control box using the provided self-drilling screws. *See Fig 1.*
2. Drill four holes in the control box so that it can be mounted onto the post.
3. Secure the control box onto the post with your choice of bolts. Use the level to make sure it's placed correctly onto the post. *See Fig 2.*
4. Install watertight connectors for the wires to keep bugs from getting into the box. *See Fig 3.*



**Fig 1.**



**Fig 2.**



**Fig 3.**

# Installation

## Light Bracket Mounting

1. Feed the screws into the drilled holes of the light bracket to avoid damage to the wires.
2. Affix the bracket onto the back of the billboard. Use the level to make sure the placement of bracket is not crooked.



# SOLAR LIGHT CONTROLLER

## 1. Important Safety Information

### 1.1 Save these instructions

This manual contains important safety, installation, and operation instructions. The following are used throughout this manual:

**WARNING:** indicates a potentially dangerous condition. Use extreme caution when performing this task.

**Caution:** indicates a critical procedure for safe and proper operation of the controller.

**Note:** indicates a procedure or function that is important for the safe and proper operation of the controller.



### 1.2 General Safety Information

- Read all of the instructions and cautions in the manual before beginning installation.
- There are no user serviceable parts inside the controller. Do not assemble or attempt to repair it.
- Install external fuses/breakers as required. Disconnect the solar module and fuse/breakers near to battery before installing or adjusting the controller.
- Confirm that power connections are tightened to avoid excessive heating from loose connections.

## 2. General Information

### 2.1 Product overview

Thank you for selecting our SLC series solar light controller that adopts the most advanced digital technique and operates fully automatically. The pulse width modulation

(PWM) batteries charging can increase the lifetime of battery. It has various unique functions and quite easy to use, such as:

- 12/24V automatic recognition.
- High efficient series PWM charging, increase the battery lifetime and improve the solar system performance
- Use MOSFET as electronic switch, without any mechanical switch,
- Widely used, automatically recognize day / night.
- Digital LEB menu, only one key solve all settings simply
- Intelligent timer function with 1-15 hours option
- Unique dual timer function, enhance the flexibility of street
- Gel, Sealed and Flooded battery type optional
- Adapt temperature compensation, correct the charging and discharging parameters automatically and improve the battery lifetime.
- Electronic protection: overheating, over charging, over discharging, overload, and shod circuit
- Polarity reverse protection: any combination of solar module and battery

The controller is for Off-grid solar system, especially in solar light system, and protects the battery from being over charged by the solar module and over discharged by the loads. The charging process has been optimized a long battery life and improved system performance. The comprehensive self-diagnostics and electronic protection functions can prevent damage from installation mistakes or system faults

The controller will automatically recognize the system rated voltage when start up. If the battery voltage is lower than 18V, it will recognize the system as 12V. If the battery voltage is higher than 18V, it will recognize the system as 24V.

### 2.2 Product Indication

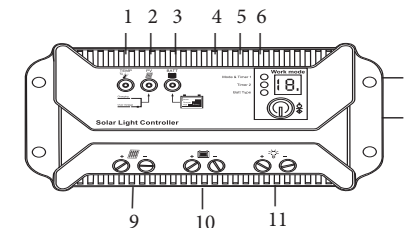

Figure 1 - Solar light controller characteristics

1. **Temperature Sensor:** measure ambient temperature and make temperature compensation for charging and discharging
2. **Charging status LED indicator:** shows charging status and also indicates when battery voltage is higher than over voltage disconnect voltage
3. **Battery status LED indicator:** shows battery life
4. **Battery typesetting indicator:** the indicator will be on when selecting battery type
5. **Timer 2 setting indicator:** will be on when setting timer 2
6. **Timer 1 setting indicator:** will be on when setting timer 1
7. **LED digital display:** displays the load work mode and status
8. **Setting button:** set load work mode and select battery type (in manual mode used for load ON/OFF)
9. **Solar module terminals:** connect solar modules
10. **Battery terminals:** connect batteries
11. **Load terminals:** connect loads

### 3. Installation Instructions

#### 3.1 General installation notes

Read through the entire installation section first before beginning installation. Be very careful when working with batteries. Wear Eye protection. Have fresh water available to wash and clean battery acid. Use insulated tools and avoid placing metal objects near the batteries. Explosive battery gases may be present during charging. Be certain there is sufficient ventilation to release the gases. Avoid direct sunlight and do not install in locations where water can enter the controller. Loose power connections and/or corroded wires may result in resistive connections that melt wire insulation, burn surrounding materials, or even cause fire. Ensure tight connections and use cable clamps to secure cables and prevent them from swaying in mobile applications. Use with GEL, Sealed or Flooded batteries only. The following instructions refer to a singular battery, but the battery connection can be made to either one battery or a group of batteries in a bank. Select the system cables according to 3A/mm<sup>2</sup> current density.

#### 3.2 Mounting

**Note:** when mounting the controller, ensure free air through the controller heat sink fins. There should be at least 5.9 inches (150mm) of clearance above and below the controller to allow for cooling. If mounted in an enclosure, ventilation is highly recommended. **Warning:** Risk of explosion! Never install the controller in a sealed enclosure with flooded batteries! Do not install in a confined space where battery gas can accumulate.

##### Step 1: Choose mounting location

Locate the controller on a vertical surface protected from direct sun, high temperature, water and good ventilation

##### Step 2: Check for clearance

Place the controller in the location where it will be mounted. Verify that there is sufficient room to run wires and there is sufficient room above and below the controller for air flow.

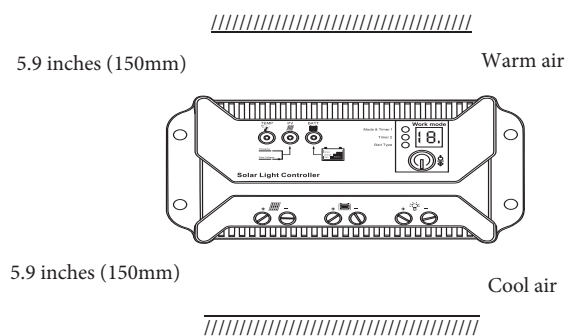

Figure 2 Mounting and cooling

##### Step 3: Mark holes

Use a pencil or pen to mark the four mounting locations on the surface.

##### Step 4: Drill holes

Remove the controller and drill 4mm holes in the marked locations.

##### Step 5: Secure controller

Place the controller on the surface and align the mounting holes with the holes drilled in step 4. Secure the controller in place using the mounting screws.

#### 3.3 Wiring

**Note:** A recommended connection order has been provided for maximum safety during installation.

**Note:** The controller is a common positive ground controller.

**Caution:** Don't connect the loads with surge power exceeding the rating of the controller.

**Caution:** For mobile applications be sure to secure all wiring. Use cable clamps to prevent cables from swaying when the vehicle is in motion. Unsecured cables create loose and resistive connections which may lead to excessive heat and/or fire.

##### Step 1: Battery Wiring

**WARNING:** Risk of explosion or fire! Never short circuit battery positive (+) and negative (-) or cables.

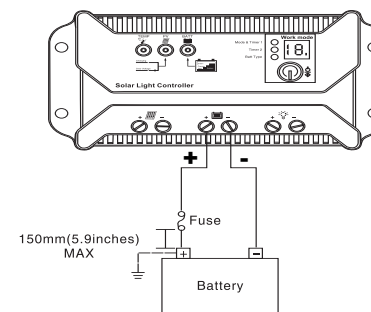

Figure 3 - Battery Wiring

Before battery is connected, make sure that the battery voltage is greater than 6V so as to start up the controller. If the system is 24V make sure the battery voltage is not less than 18V. System voltage can only be automatically recognized when the controller starts up for the first time. When installing the fuse, make sure that the biggest distance between the fuse holder and the positive terminal of the battery is 5.9 inches. Do not insert a fuse at this time. Confirm the connection is correct and turn on the power.



# SOLAR LIGHT CONTROLLER

## 3.3 Wiring Continued

### Step 2: Load Wiring

The controller loads can be connected to such electrical equipment as lights, pumps, motors, etc. Controllers offer power to loads through the battery.

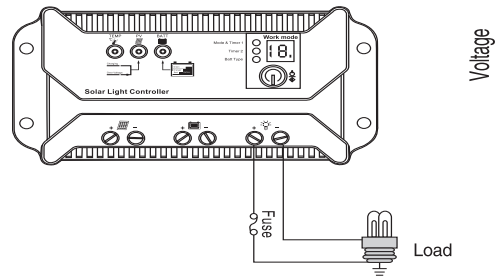

Figure 4 - Load Wiring

Connect the positive (+) and negative (-) of loads to the controller load terminals as shown in figure 4. Voltage may exist in the load terminal, connect carefully to avoid short circuit. An in-line fuse holder should be wired in series with the load positive (+) or negative (-) wire as shown in figure 4. Do not insert a fuse at this time. Confirm the connection is correct and turn on the power. If wiring the load connection to a load distribution panel, each load circuit should be fused separately. The total load draw should not exceed the load rated current of the controller.

### Step 3: Solar Panel Wiring

**WARNING:** Risk of electric shock! Use extensive caution when handling and installing solar wiring. The solar modules high voltage output can cause severe shock or injury.

The controller can accept 12V and 24V nominal off-grid solar modules. Grid-tie solar modules may be used if the open circuit voltage of solar module doesn't exceed the maximum PV input voltage of the controller. The solar modules working voltage must be equal to or higher than the system voltage.

Solar Module

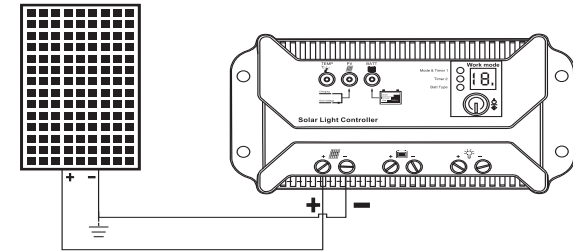

Figure 5 - Solar Panel Wiring

### Step 4: Confirm wiring

Double-check the wiring in step 1 through 3. Confirm correct polarity at each connection. Verify that all six terminals are tightened.

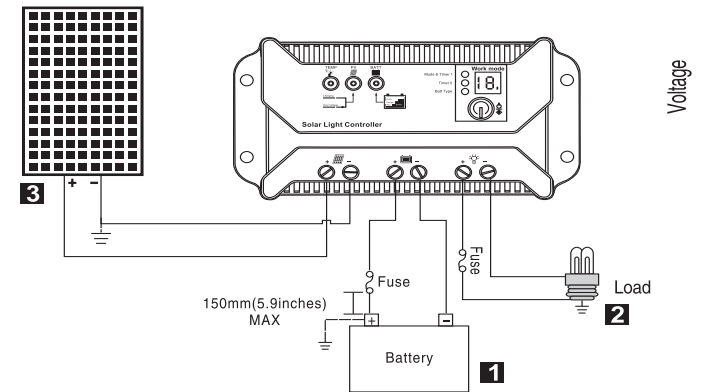

Figure 6 - System Wiring Review

# SOLAR LIGHT CONTROLLER

## Step 5: Confirm power is on

When battery power is applied and the controller starts up, the battery LED indicator will be green. If the controller doesn't start up, or the battery status LED presents an error, please refer to section 5 for troubleshooting.

## 4. PWM Charging Information

**4.1 PWM technology (Pulse Width Modulation):** the controller adopts the advanced PWM charging mode. With range of 0 - 100%, it can charge the battery quickly and stably under any condition of solar photo-voltaic system. PWM charging mode uses automatic conversion duty ratio pulses current to charge the battery. The battery can be fully charged safely and rapidly with the pulse current. Intermissions make some oxygen and hydrogen generated by chemical reaction chemically combined again and absorbed. It can eliminate concentration polarization naturally and reduce the internal pressure of the battery so that the battery can absorb more power. Pulse current charging mode makes the battery have more time to react, which reduces the passing volume and makes the battery improve the acceptance rate of charging current.

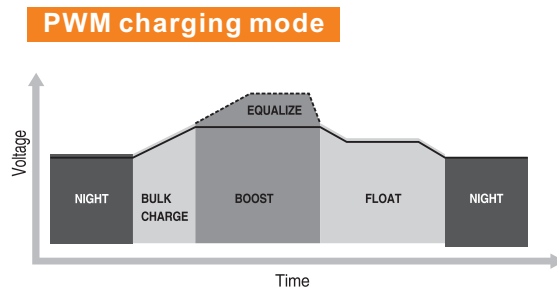

Figure 7 - PWM charging mode

**4.2 Bulk Charge:** In this stage, the battery voltage has not yet reached boost voltage and 100% of available solar power is used to charge the battery.

**4.3 Boost Charge:** When the battery has reached to the boost voltage set point, constant current regulation is used to prevent heating and excessive battery gassing. The boost range remains for 120 minutes and then goes to float charge.

**4.4 Float Charge:** After the battery is fully charge in boost voltage stage, the controller reduces the battery voltage to float voltage set point. When the battery is fully charged, there will be no more chemical reactions and all the charge currents transmit into heat and gas at this time. The controller reduces the voltage to the floating stage, charging with a smaller voltage and current. It will reduce the temperature of the battery and prevent the gassing, also charging the battery slightly at the same time. The purpose of the float stage is to offset the power consumption caused by self consumption and small loads in the whole system, while maintaining full battery storage capacity. In float stage, loads can continue to draw power from the battery. In the event that the system load(s) exceed the solar charge current, the controller will no longer be able to maintain the battery at the float set point. Should the battery voltage remain below the boost reconnect charging voltage, the controller will exit float stage and return to bulk charge.

**4.5 Equalize Charge:** Certain types of batteries benefit from periodic equalizing charge, which can stir the electrolyte, balance battery voltage and complete chemical reaction. Equalizing charge increases the battery voltage, higher than the standards complement voltage; which gasifies the battery electrolyte. If the battery is being overcharged, the solar controller will automatically turn to equalize charging stage, which remains for 120 minutes.

Equalize charge and boost charge are not carried out constantly in a full charge process to avoid too much gas precipitation or overheating of battery.

**WARNING:** Risk of explosion! Equalizing flooded battery can produce explosive gases, the battery box must be well ventilated at all times.

**Note:** Equalization may increase battery voltage to a level damaging to sensitive DC loads. Ensure that all loads allowable input voltage are higher than the equalizing charging set point voltage.

**Note:** Equipment damage! Over-charging and excessive gas precipitation may damage the battery plates and activate material shedding on them. Too high of an equalizing charge or for too long may cause damage. Please carefully review the specific requirements of the battery used in the system.

## 5. LED Indicators

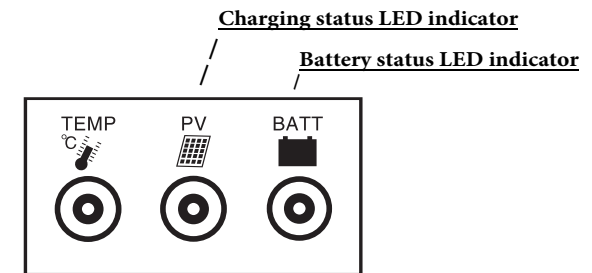

Figure 8 - LED indicators

### 5.1 Charging status indicator

Green ON whenever sunlight is available for battery charging

Color	Indicator	Charging Status
Green	On solid	Charging

### 5.2 Battery status indicator

Green ON when battery voltage is in normal range.

Green slowly flashing when battery is full

Orange ON when battery is under voltage

Red ON when battery is overcharged

Color	Indicator	Battery status
Green	On solid	Normal
Orange	On solid	Under voltage
Red	On solid	Overcharged

# SOLAR LIGHT CONTROLLER

## 6. Setting Operation

### 6.1 Dual timer function

#### Timer Control Mode



The default night length is 10 hours. The controller can learn the night length referring to the previous night and adapt to the different seasons. However, the learning process will take some time.

**Note:** when the OFF time set at timer 2 is later than local sunrise time, the controller will turn off the load output at the sunrise time, which shows light control first.

### 6.2 Load control settings

#### 6.2.1 Dusk to Dawn

When solar module voltage goes below the point of NTTV (night time threshold voltage) at sunset, the controller will recognize the starting voltage and turn on the load after 10 minutes delay. When solar voltage goes above point of DTTV (day time threshold voltage), the solar controller will recognize the starting voltage and turn off the load after 10 minutes delay.

#### 6.2.2 Light ON + timer

When solar module voltage goes below the point of NTTV at sunset, the solar controller will recognize the starting voltage and turn on the load after 10 minutes delay. The load will be on for several hours which uses set through LED digital tube.

#### 6.2.3 Testing Mode

This mode is the same as Dusk to Dawn, without the 10 minute delay when the controller recognizes the starting voltage. When below the starting voltage, the controller will turn on the load. If higher, it will turn off the load. The test mode makes it easy to check the system installation.

#### 6.2.4 Manual Mode

This mode is to turn ON and OFF the load by manual.

## 7. Load Work Mode Setting

Press the setting button once and the setting indicators will be changed once among timer 1, timer 2 and battery type.

When timer 1 setting indicator is on, press the setting button for more than 5 seconds will the LED digital tube flashes. Then press the setting button till the desired number appears according to the following table. The setting is finished when the digital tube stops flashing. Timer 2 setting is the same as timer 1 when the setting indicator is on timer 2.

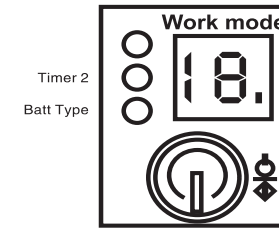

Figure 9 - Setting operation indicating

### Load Work mode

Timer 1	LED digital No.
Disable	n
Dusk to dawn, load will be on all night	0
Following sunset load will remain on for 1 hour after the 10 minute delay	1
Following sunset load will remain on for 2 hours after the 10 minute delay	2
Following sunset load will remain on for 3 hours after the 10 minute delay	3
Following sunset load will remain on for 4 hours after the 10 minute delay	4
Following sunset load will remain on for 5 hours after the 10 minute delay	5
Following sunset load will remain on for 6 hours after the 10 minute delay	6
Following sunset load will remain on for 7 hours after the 10 minute delay	7
Following sunset load will remain on for 8 hours after the 10 minute delay	8
Following sunset load will remain on for 9 hours after the 10 minute delay	9
Following sunset load will remain on for 10 hours after the 10 minute delay	10
Following sunset load will remain on for 11 hours after the 10 minute delay	11
Following sunset load will remain on for 12 hours after the 10 minute delay	12
Following sunset load will remain on for 13 hours after the 10 minute delay	13
Following sunset load will remain on for 14 hours after the 10 minute delay	14
Following sunset load will remain on for 15 hours after the 10 minute delay	15
Test mode	16
ON/OFF mode	17

# SOLAR LIGHT CONTROLLER

## Load Work mode

Timer 2	LED digital No.
Disable	n
Load will be on for 1 hour prior to sunrise	1
Load will be on for 2 hours prior to sunrise	2
Load will be on for 3 hours prior to sunrise	3
Load will be on for 4 hours prior to sunrise	4
Load will be on for 5 hours prior to sunrise	5
Load will be on for 6 hours prior to sunrise	6
Load will be on for 7 hours prior to sunrise	7
Load will be on for 8 hours prior to sunrise	8
Load will be on for 9 hours prior to sunrise	9
Load will be on for 10 hours prior to sunrise	10
Load will be on for 11 hours prior to sunrise	11
Load will be on for 12 hours prior to sunrise	12
Load will be on for 13 hours prior to sunrise	13
Load will be on for 14 hours prior to sunrise	14
Load will be on for 15 hours prior to sunrise	15

☞ **Note:** If timer 1 is dusk to dawn (0), test mode (16) or ON/OFF mode (17), timer 2 will be disabled.

## 8. Battery Type Setting

When battery type setting indicator is on, press the setting button for more than 5 seconds till the LED digital tube flashes, then press the setting button till the desired number appears according to the following table. The setting is finished till the LED digital display stops flashing.

Battery Type	Digital tube display
Gel Battery	1
Sealed lead acid battery	2
Flooded battery	3

## 9. Protection

- **PV array short circuit:** If PV short circuit occurs, clear it to resume normal operation.
- **Load overload:** If the load current exceeds the maximum load current rating, the controller will disconnect the load. Overloading must be cleared up through reapplying power or pressing the setting button.
- **PV reverse polarity:** Fully protected against PV reverse polarity, preventing any damage to the controller. Correct the mis-wire to resume normal operation.
- **Battery reverse polarity:** Fully protected against battery reverse polarity, preventing any damage to the controller. Correct the mis-wire to resume normal operation.
- **Damaged local temperature sensor:** If the temperature sensor is damaged or short circuit occurs, the controller will be charging or discharging at the default temperature 77 degrees F to prevent damaging the battery and overcharging or discharging.
- **Overheating protection:** If the temperature of the controller's heat sink exceeds 185 degrees F, the controller will automatically start the overheating protection.
- **High voltage transients:** PV is protected against high voltage transients. In lightning prone areas, additional external suppression is recommended.

## 10. Troubleshooting

Faults	Possible reasons	Troubleshooting
Charging LED indicator off during daytime when sunshine falls on PV modules property	PV array disconnection	Check that the PV and battery wire connections are correct and tight
Green charging LED indicator flashing fast	Battery voltage higher than OVD (over voltage disconnect)	Check if battery voltage is over high, disconnect the solar module
Battery LED indicators are orange	Battery under voltage	Load output is normal, charging LED indicator will return to green automatically when fully charged
Battery LED indicators are red and loads are not working	Battery over discharged	The controller cuts off the output automatically, LED indicator will return to green automatically when fully charged



# SOLAR LIGHT CONTROLLER

## 11. Technical Specifications

### Specifications

Model	SLC12/24-05	SLC12/24-10	SLC12/24-15	SLC12/24-20
Normal system voltage	12/24V DC auto. work			
Maximum battery voltage	32V			
Rated charge current	5A	10A	15A	20A
Charge circuit voltage drop	≤ 0.26V			
Discharge circuit voltage drop	≤ 0.15V			
Self-consumption	≤ 6mA			
NTTV(night time threshold voltage)	12V system: 5V			
	24V system: 10V			
DTTV(daytime threshold voltage)	12V system: 6V			
	24V system: 12V			
Temperature compensation coefficient(TEMPCO)*	30Mv/°C/12V( 25C ref) compensation of equalization, boost, float and low voltage disconnect voltage.			
Working temperature	-35°C ~+55°C			
Storage temperature	-35°C ~+80°C			
Humidity	10%-90% NC			
Enclose	Ip30			
Overall dimension	150x82x50mm			
Terminal	6mm <sup>2</sup>			
Net weight	0.35kg			

Charging parameters			
Battery charging setting	Gel	Sealed	Flooded
Over voltage disconnect voltage	16V; X 2/24V		
Charging limit voltage	15.5V; x 2/24V		
Over voltage reconnect voltage	15V; x 2/24V		
Equalize charging voltage	14.4V; X2/24V	14.6V; X2/24V	14.8V; X2/24V
Boost charging voltage	14.2V; X 2/24V	14.4V; x 2/24V	14.6V; X 2/24V
Floating charging voltage	13.8V; x 2/24V		
Boost reconnect charging voltage	13.2V; x 2/24V		
Low voltage reconnect voltage	12.6V; X 2/24V 12V; ~ 2/24V		
Under voltage warning reconnect voltage	11.1 V; x 2/24V		
Low voltage disconnect voltage	10.8V; X 2/24V		
Discharging limit voltage	2 hours		
Equalization duration	2 hours		

## 12. Warranty

The solar lighting controller is warranted to be free from defects for a period of 2 years from the date of shipment to the original recipient. We will repair or replace any such defective products.

### 12.1 Claim procedure:

**Before requesting warranty service, check the operation manual to rule out possible solutions to the issue. If no solution is present, prepaid shipping costs will be provided to return the defective product to us.**

**Provided proof of date and place of purchase is required.**

**To obtain rapid service under this warranty the returned products must include:**

- Model number
- Serial number
- The module type and size
- The type of batteries and system loads
- Detailed description of the defect/failure and reason for return

### 12.2 This warranty does not apply under the following conditions;

- Damage by accident, negligence, abuse or improper use
- PV or load current exceeding the rating of product
- Unauthorized product modification or attempted repair
- Damage occurring during shipment
- Damage results from acts of nature such as lightning, water, extreme weather
- Irrecoverable mechanical damage